

Article number: 204150M863D0S

Description: E+G levelling foot  
GN 41-50-M8-63-D0-S

Note: S Without nut, External hexagon at the bottom

## Measures

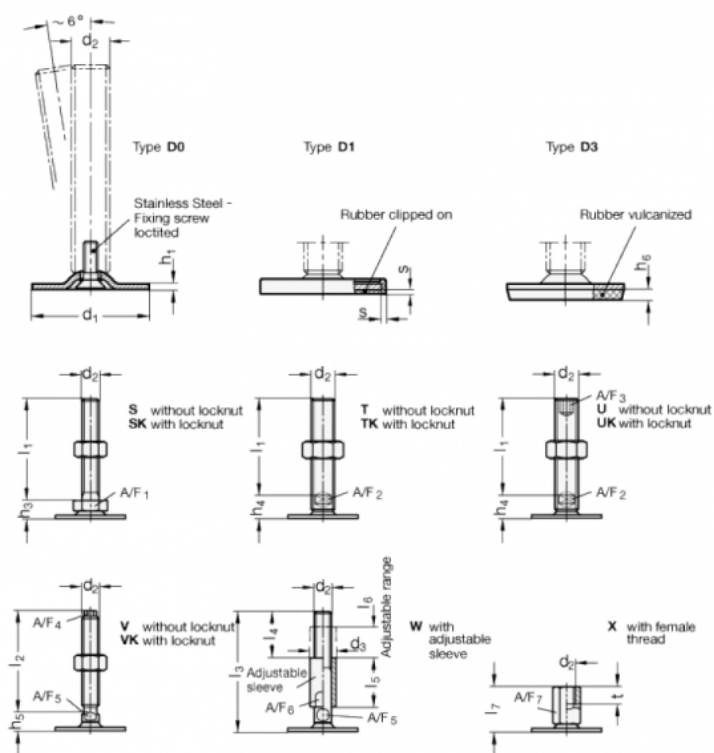

A/F1	= 17
d1	= 50
d2	= M8
h1	= 2.5
h3	= 11
h6	=
l1	= 63
s	=